

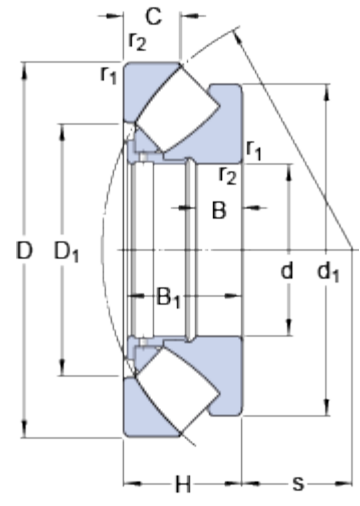

# 294/710

## Dimensions



d	710	mm
D	1220	mm
H	308	mm
d <sub>1</sub>	≈ 1110	mm
D <sub>1</sub>	≈ 917	mm
B	117	mm
B <sub>1</sub>	298	mm
C	149	mm
s	415	mm
r <sub>1,2</sub>	min. 15	mm

## Abutment dimensions

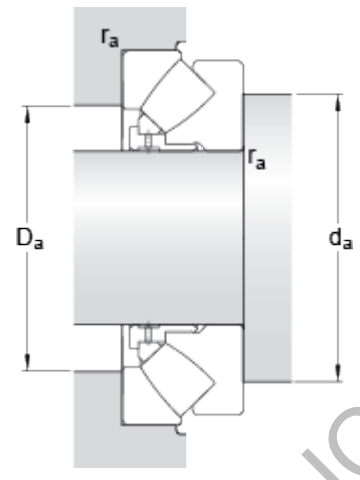

d <sub>a</sub>	min. 965	mm
D <sub>a</sub>	max. 1070	mm
r <sub>a</sub>	max. 12	mm

## Calculation data

Basic dynamic load rating	C	17600	kN
Basic static load rating	C <sub>0</sub>	76500	kN
Fatigue load limit	P <sub>u</sub>	5000	kN
Reference speed		220	r/min
Limiting speed		430	r/min
Minimum axial load factor	A	560	

## Mass

Mass bearing		1500	kg
--------------	--	------	----